

## 3-TERMINAL 1.5A POSITIVE ADJUSTABLE REGULATOR

The KIA317F/PI is adjustable 3-terminal positive voltage regulator capable of supplying in excess of 1.5A over a 1.25V to 37V output range. This is exceptionally easy to use and require only two external resistors to set the output voltage. Further, both line and load regulation are better than standard fixed regulators.

### FEATURES

- Adjustable output between 1.25V and 37V
- Guaranteed 1.5A output current
- Line regulation typically 0.001%/V
- Load regulation typically 0.1%
- 80dB ripple rejection (with Cadj)
- Internal thermal overload protection
- Internal short-circuit current limiting
- Output transistor safe-area compensation
- Suffix U : Qualified to AEC-Q100  
ex) KIA317F-RTF/PU

### MAXIMUM RATINGS (Ta=25 °C)

CHARACTERISTIC		SYMBOL	RATING	UNIT
Input-Output Voltage Differential		$V_{IN}$	40	V
Output Current		$I_{OUT}$	1.5	A
Power Dissipation (No Heatsink)	F DPAK	$P_D$	1.3	W
	PI TO-22IS		2.0	
Operating Junction Temperature		$T_j$	-40 ~ 150	
Operating Temperature		$T_{opr}$	-40 ~ 125	
Storage Temperature		$T_{stg}$	-65 ~ 150	
Lead Temperature		$T_{lead}$	230	

### BLOCK DIAGRAM

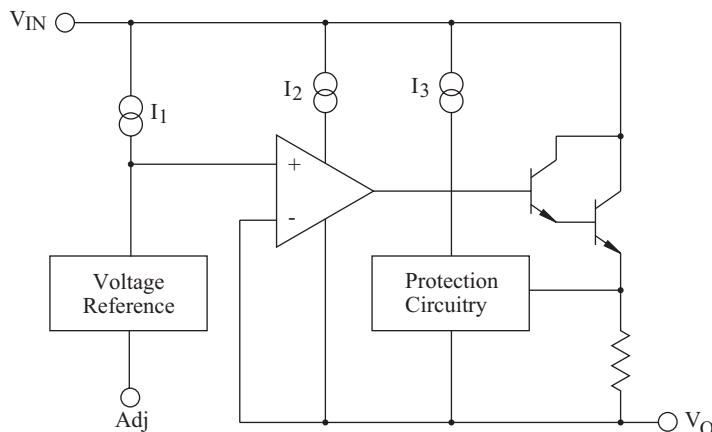

# KIA317F/PI

## ELECTRICAL CHARACTERISTICS (Ta=25 °C)

(Vin-Vo=5V, Io=0.5A, 0 ≤ Tj ≤ 125 °C, I\_MAX=1.5A, unless otherwise specified.)

CHARACTERISTIC	SYMBOL	TEST CONDITION	MIN.	TYP.	MAX.	UNIT
Line Regulation	Vo(Line)	Ta=25 °C, Io=10mA	-	0.01	0.04	% / V
		Ta=0 to 125 °C, Io=10mA	-	0.02	0.07	
Load Regulation	Vo(Load)	Ta=25 °C	-	0.1	0.5	%
		Ta=0 to 125 °C	-	0.3	1.5	
Adjustable Pin Current	IAdj		-	50	100	μA
Adjustable Pin Current Change	IAdj	10mA Io I_MAX, 3V Vin-Vout 40V	-	0.2	5	μA
Reference Voltage	Vref	10mA Io I_MAX, 3V Vin-Vout 40V, P P_MAX	1.20	1.25	1.30	V
Temperature Stability	ST_T	T_Min Tj T_MAX	-	1	-	%
Minimum Load Current to Maintain Regulation	Io(MIN)	(Vin-Vout)=40V	-	3.5	10	mA
Current Limit	Io(MAX)	(Vin-Vout) 15V, P P_MAX	1.5	2.2	3.4	A
		(Vin-Vout) 40V, P P_MAX, Ta=25 °C	0.15	0.4	-	A
Output Noise Voltage	VNO	Ta=25 °C, 10Hz ≤ f ≤ 10kHz, % of Vout	-	0.0003	-	%
Ripple Rejection Ratio	RR	Vo=10V, f=120Hz	-	65	-	dB
		CAdj=10μF	66	80	-	
Long Term Stability	ST	Ta=25 °C for end point measurement, 1000 Hr	-	0.3	1	%

Note : Load and line regulation are specified at constant junction temperature.

Change in Vo due to heating effects must be taken into account separately. Pulse testing with low duty is used.

## TYPICAL APPLICATION (PROGRAMMABLE REGULATOR)

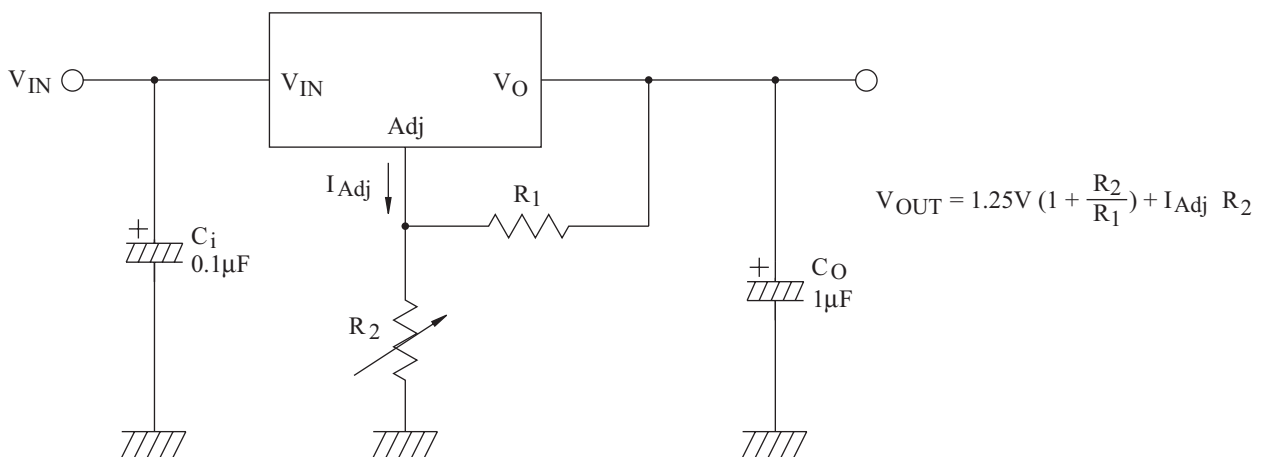

Ci is required when regulator is located an appreciable distance from power supply filter.

Co is not needed for stability, however, in the range of 1μF to 100μF of aluminum or tantalum electrolytic are commonly used to provide improved output impedance and rejection of transients.

Since IAdj is controlled to less than 100μA, the error associated with this term is negligible in most applications.

Fig1. Load Regulation

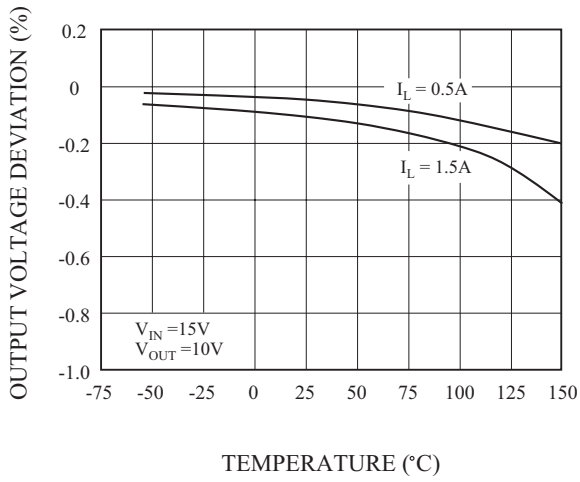

Fig2. Current Limit

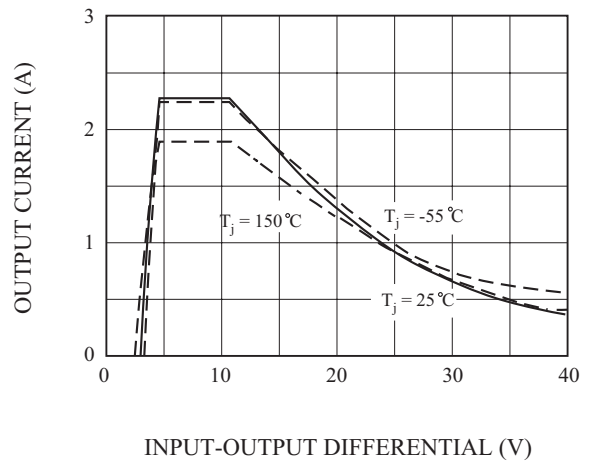

Fig3. Adjustment Current

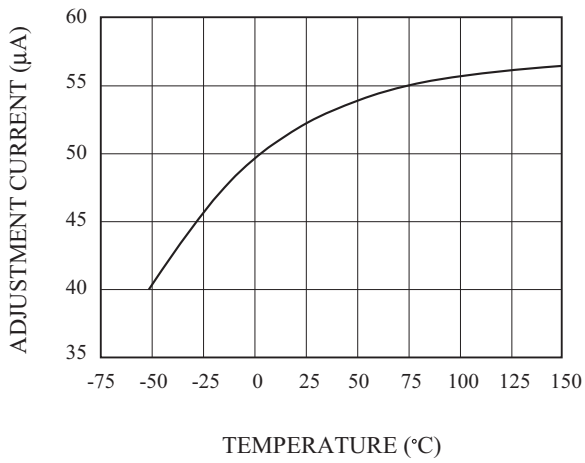

Fig4. Dropout Voltage

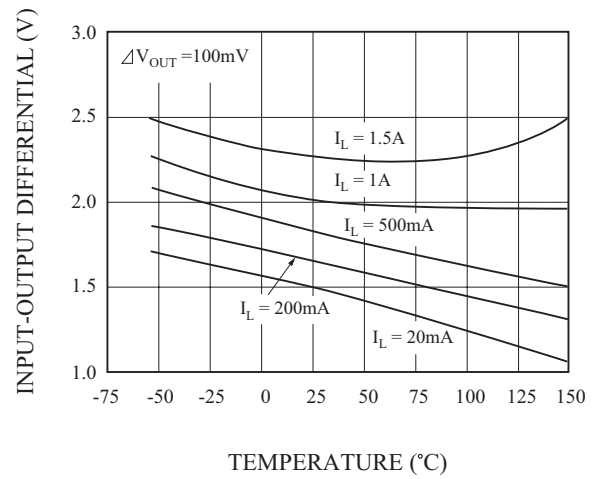

Fig5. Temperature Stability

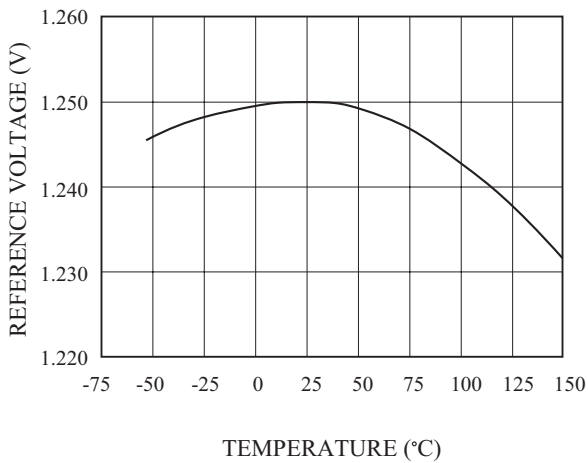

Fig6. Minimum Operating Current

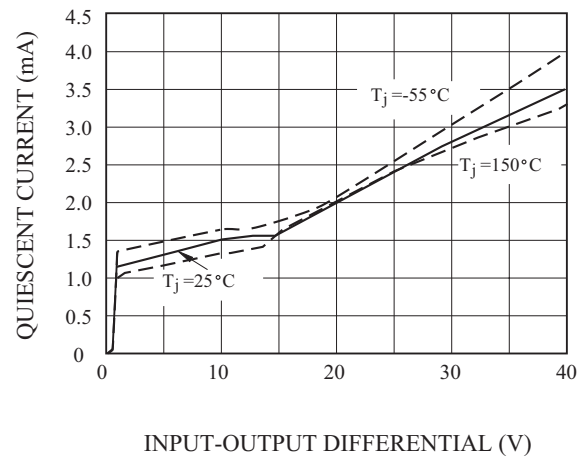

Fig7. Ripple Rejection

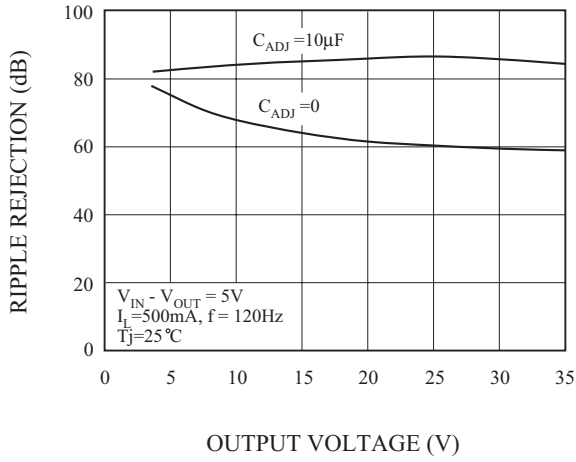

Fig8. Ripple Rejection

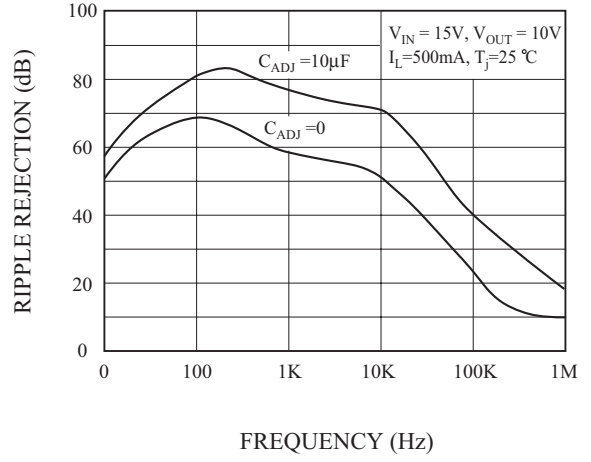

Fig9. Ripple Rejection

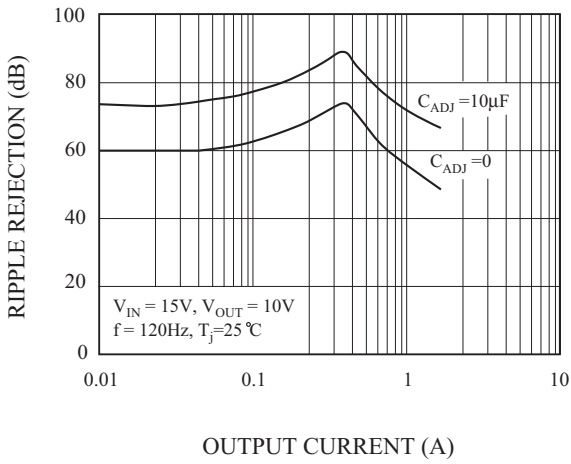

Fig10. Output Impedance

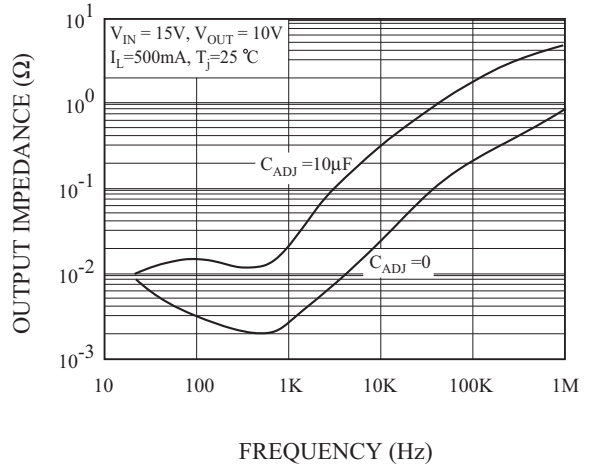

Fig11. Line Transient Response

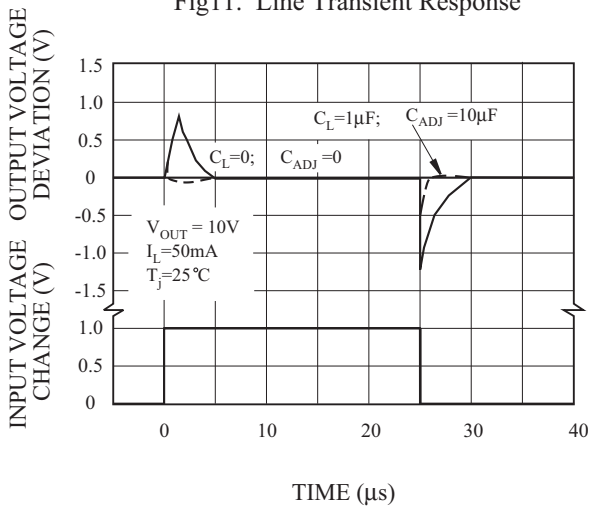

Fig12. Line Transient Response

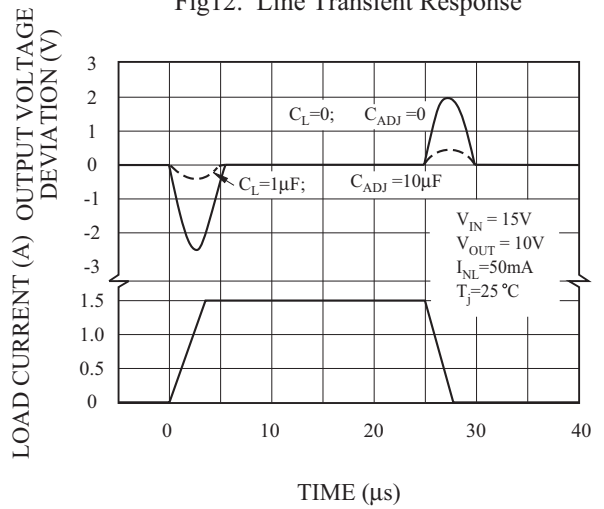

Fig13. Power Dissipation-2 (DPAK)

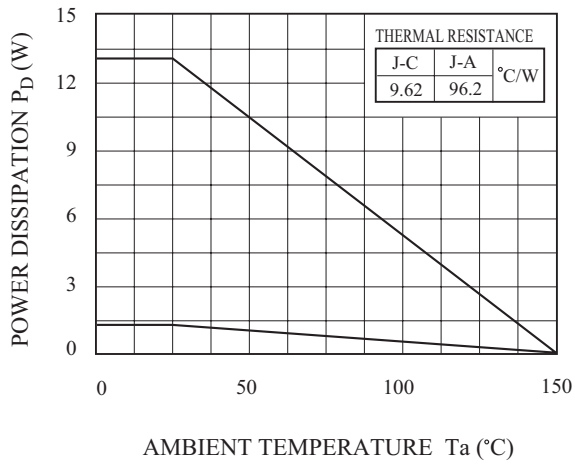
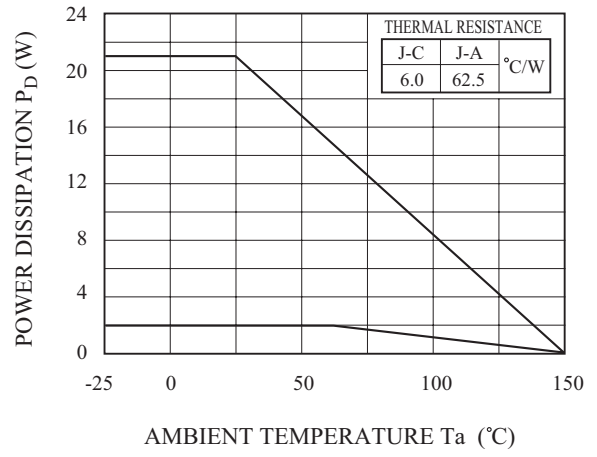

Fig14. Power Dissipation-1 (TO-220IS)



# KIA317F/PI

